

## ■ Features

- Colorless transparency lens type
- $\phi 3\text{mm}$ (T-1) all plastic mold type
- High luminosity
- ESD Class(Mil Std-883d Method 3015.7) based on Human Body Model(HBM) : 950V

## ■ Outline dimensions

(unit : mm)

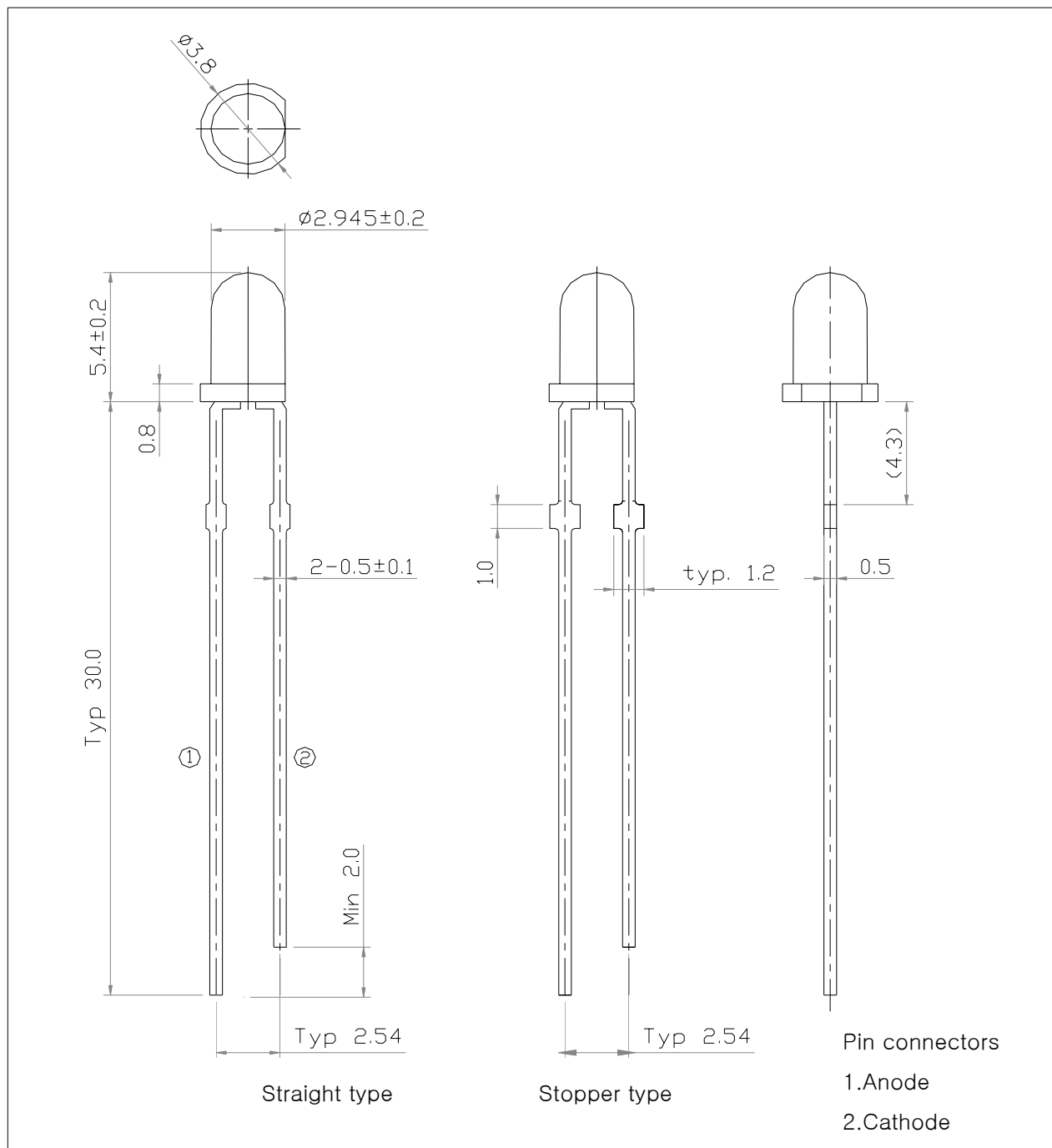

## ■ Absolute maximum ratings

Characteristic	Symbol	Ratings	Unit
Power dissipation	$P_D$	120	mW
Forward Current	$I_F$	30	mA
* <sup>1</sup> Peak Forward Current	$I_{FP}$	100	mA
Reverse Voltage	$V_R$	5	V
Operating Temperature	$T_{opr}$	-30~85	°C
Storage Temperature	$T_{stg}$	-40~100	°C
* <sup>2</sup> Soldering Temperature	$T_{sol}$	260°C for 3 seconds	

\*1. Duty ratio = 1/16, Pulse width = 0.1ms

\*2. Keep the distance more than 2.0mm from PCB to the bottom of LED package

## ■ Electrical – Optical characteristics

(Ta=25°C)

Characteristic	Symbol	Test Condition	Min.	Typ.	Max.	Unit
* <sup>3</sup> Forward Voltage	$V_F$	$I_F=20\text{mA}$	-	3.3	4.0	V
ESD Check Forward Voltage	$V_{F2}$	$I_F=10\mu\text{A}$	2.0	-	-	V
Reverse Current	$I_R$	$V_R=5\text{V}$	-	-	50	uA
* <sup>4</sup> Half Angle	$\theta_{1/2}$	$I_F=20\text{mA}$	-	±17	-	deg

\*3. Voltages are tested at a current pulse duration of 1 ms and an accuracy of ±0.1V

\*4.  $\theta_{1/2}$  is the off-axis angle where the luminous intensity is 1/2 the peak intensity

■ Chromaticity Coordinates ranks

(Ta=25°C)

Color RANK		Test Condition	Min.	Typ.	Max.
9	x	I <sub>F</sub> = 20mA	0.24	–	0.26
	y		0.19	–	0.25
0	x		0.26	–	0.28
	y		0.22	–	0.28
1	x		0.28	–	0.30
	y		0.25	–	0.31
2	x		0.30	–	0.32
	y		0.28	–	0.34
3	x		0.32	–	0.34
	y		0.30	–	0.36

\* The CIE standard colorimetric system

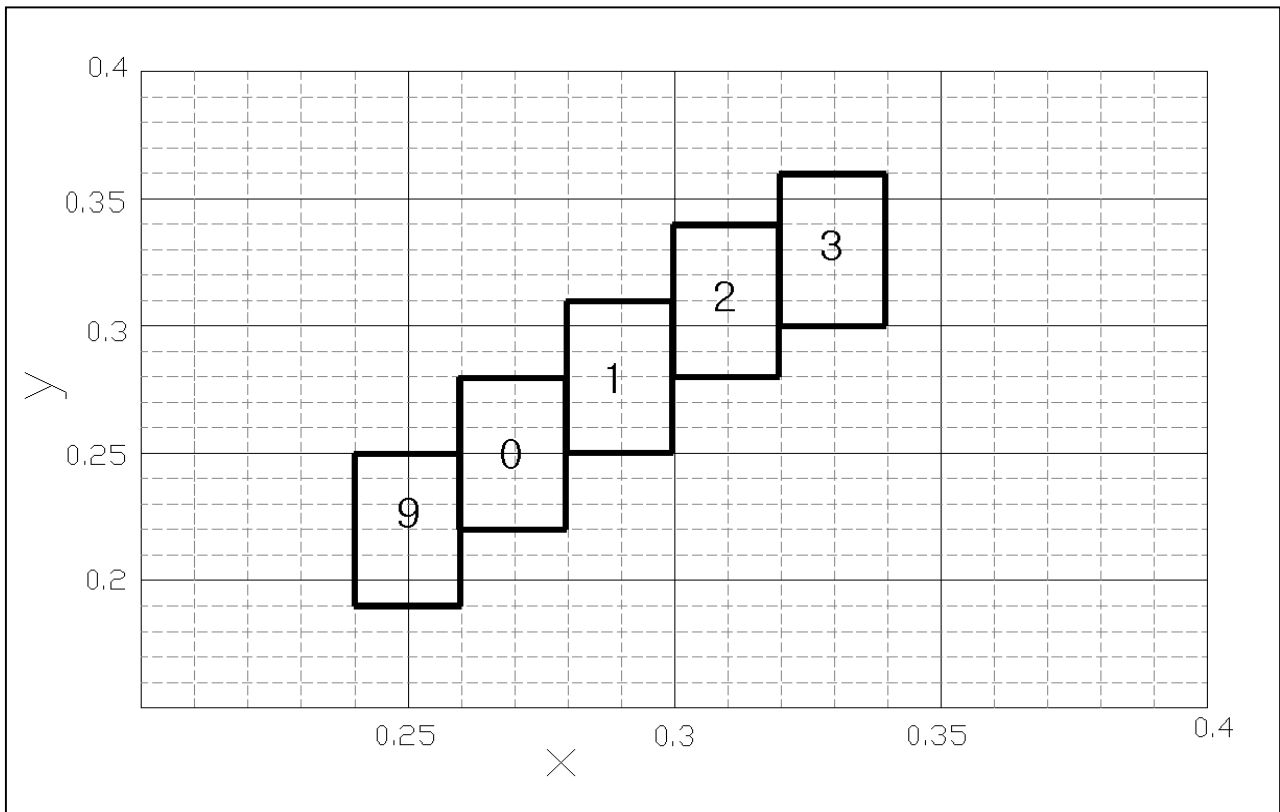

## ■ Luminous intensity ranks

(Ta=25°C)

Iv RANK	Test Condition	Min.	Typ.	Max.	Unit
Q	I <sub>F</sub> = 20mA	1700	–	2400	mcd
R		2400	–	3400	
S		3400	–	4800	

\* Luminous intensity is tested at a current pulse duration of 25 ms and an accuracy of ±11%.

\* Intensity Measured : 0.01sr(CIE. LED\_B)

## ■ Precautions On LED using

\* To avoid optical difference, Please do not mix differently-ranked product.

## ■ Characteristic Diagrams

Fig. 1  $I_F$ - $V_F$

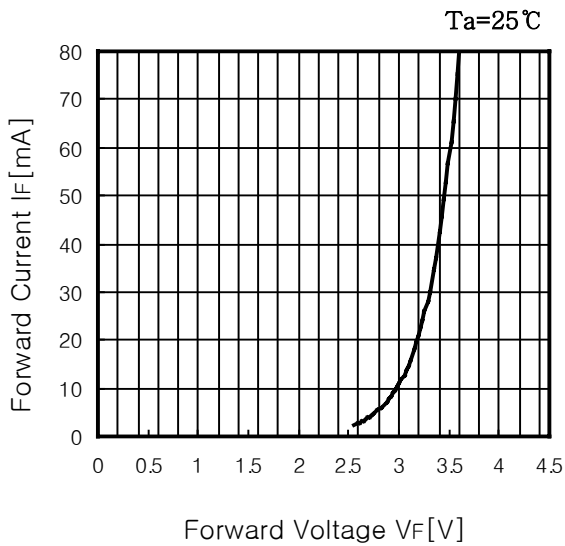

Fig. 2  $I_V$ - $I_F$

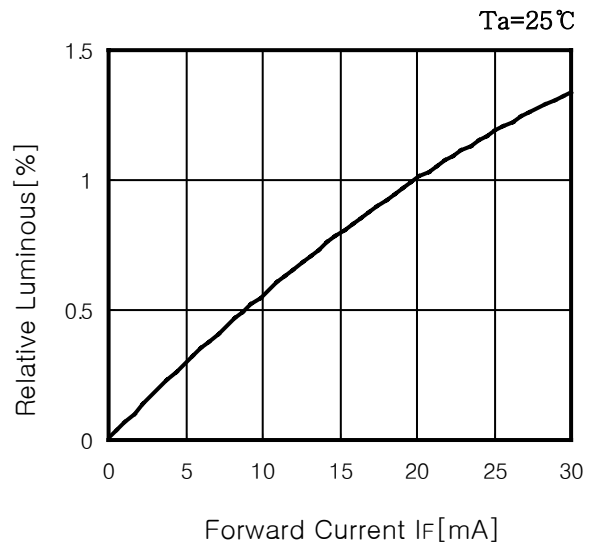

Fig. 3  $I_F$ - $T_a$

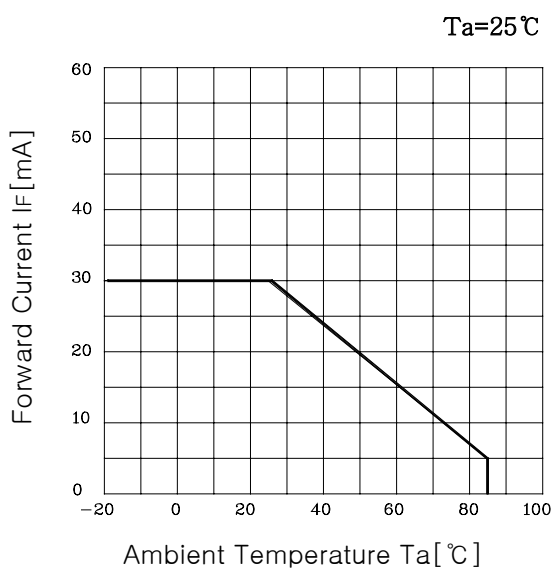

Fig. 4 Radiation Characteristics

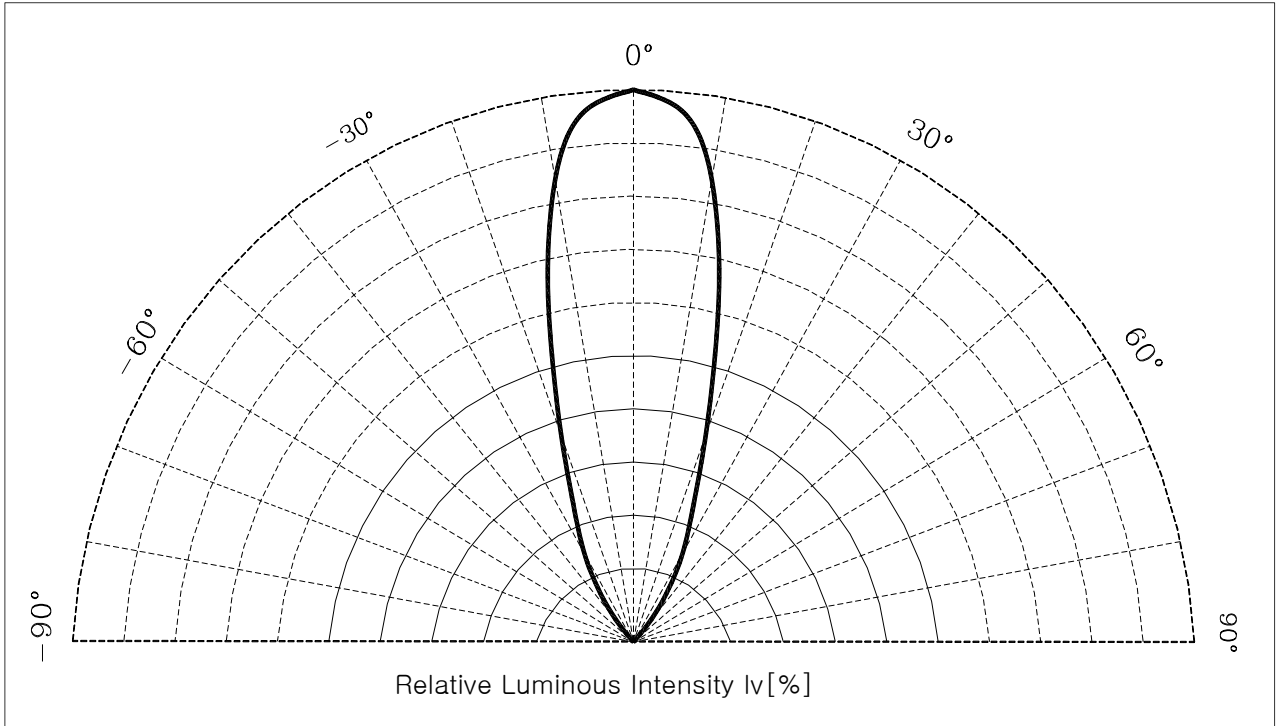
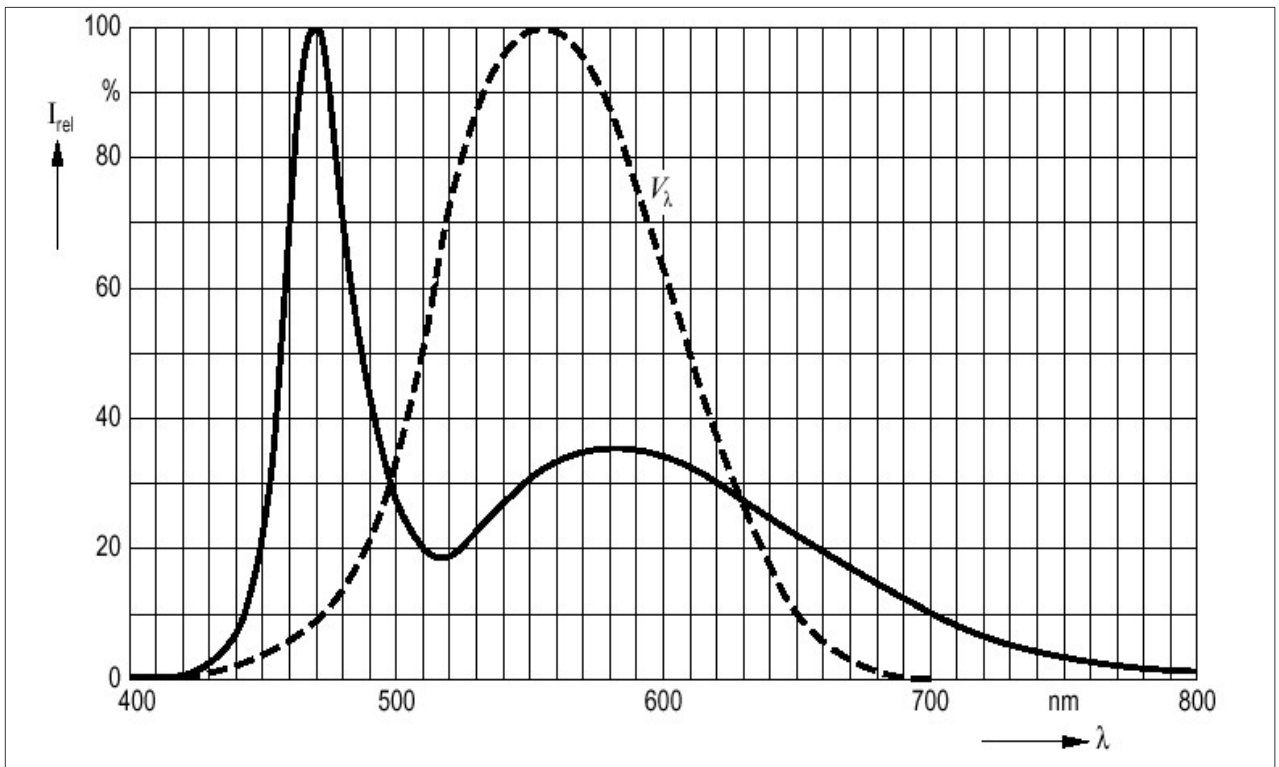

Fig. 5 Spectrum Characteristic

( $T_a=25^\circ\text{C}$  ,  $I_F = 20\text{mA}$ )



■ Revision history sheet

Spec NO.			
Title	Specification for Approval		
Times	Date	Summary of revision	Remarks
1	2001. 07. 15	신규제정	
2	2003. 02. 26	Format 변경	