

Specification for Approval

(Ver 1.0)

Part No. : LIB1000

comments

Designed by	Checked by	Approved by
/	/	/

Approved by	Approved by	Approved by
/	/	/

Date :

Date :

- CONTENTS -

1. Features
2. Package Outline Dimensions and Materials
3. Absolute Maximum Ratings
4. Electro-Optical Characteristics
5. CIE Chromaticity Diagram
6. Materials
7. Taping
8. Packing
9. Reliability
10. Cautions
11. Warranty
12. Characteristic Diagrams

1. Features

- Package : SMD type (1 Chip and 1 Zener in 1 PKG)
- 1.6 × 0.8 × 0.4 [mm] (L×W×H) size surface mount type
- Viewing angle : extremely wide(160°)
- Reflow : Pb-Free Reflow

2. Package Outline Dimensions and Recommended Solder Patterns

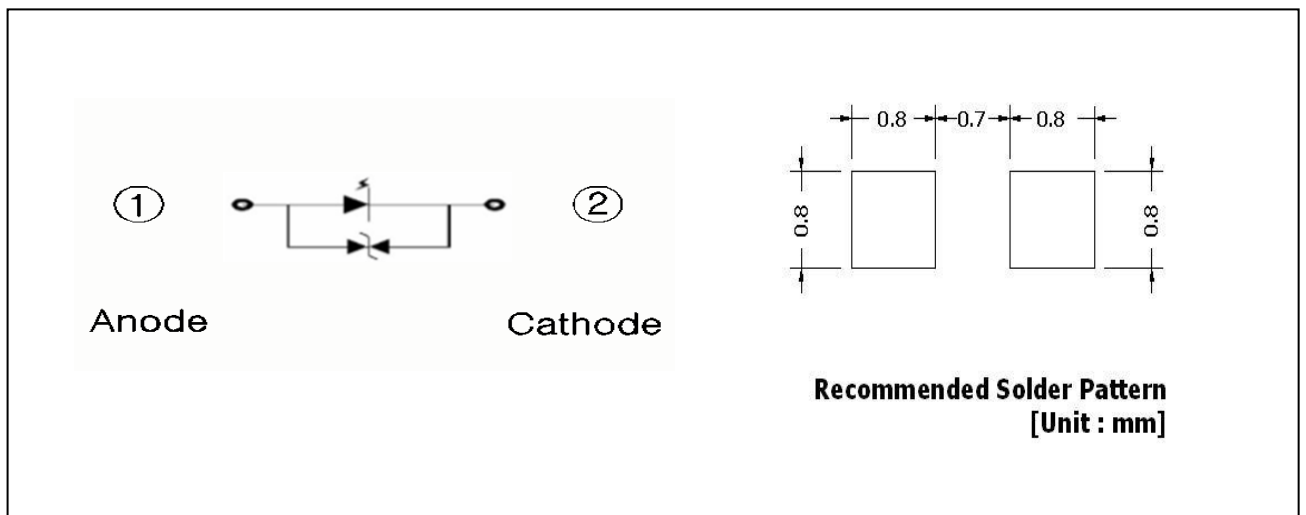
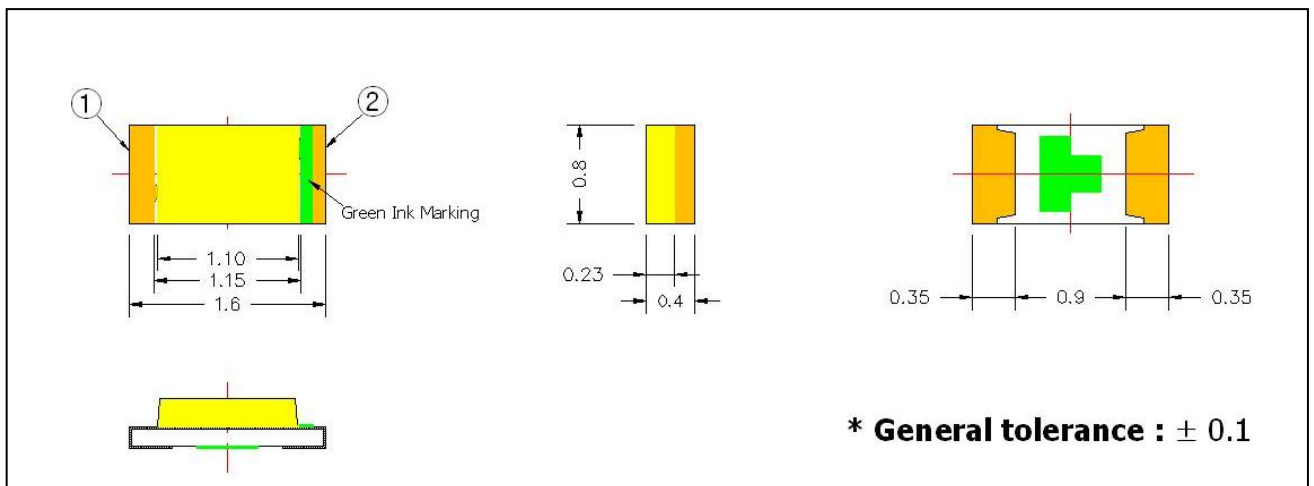

3. Absolute Maximum Ratings

(Ta=25°C)

item	symbol	value	unit
forward current	I_F	20	mA
pulse forward current ¹⁾	I_{FP}	100	mA
reverse voltage	V_R	5	V
power dissipation	P_D	70	mW
operating temperature	T_{opr}	-30 to+85	°C
storage temperature	T_{stg}	-40 to +85	°C

¹⁾ I_{FP} conditions : pulse width $\leq 10\text{msec}$ & duty ratio $\leq 1/10$

* Absolute Maximum ratings is not normal operating condition.

4. Electro-Optical Characteristics

(Ta=25°C, $I_F=5\text{mA}$)

item	rank	symbol	condition	min	typ	max	unit
forward voltage ²⁾	V26	V_F	$I_F=5\text{mA}$	2.60	-	2.70	V
	V27			2.70	-	2.80	
	V28			2.80	-	2.90	
	V29			2.90	-	3.00	
	V30			3.00	-	3.10	
Luminous intensity ³⁾	2E10	I_V	$I_F=5\text{mA}$	100	-	150	mcd
	2E15			150	-	200	
	2E20			200	-	250	
	2E25			250	-	300	
reverse voltage	-	V_R	$I_R=10\text{mA}$	-	-	2.0	V

²⁾ Forward voltages are tested at a current pulse duration of 10 ms and an accuracy within $\pm 0.1\text{V}$.

³⁾ The allowance of luminous intensity measurement is within $\pm 11\%$.

* To avoid optical difference, please do not mix differently ranked product.

* All measurements were made under the standardized environment of LUXPIA.

5. CIE Chromaticity Diagram ⁴⁾

($T_a=25\text{ }^\circ\text{C}$, $I_F=5\text{mA}$)

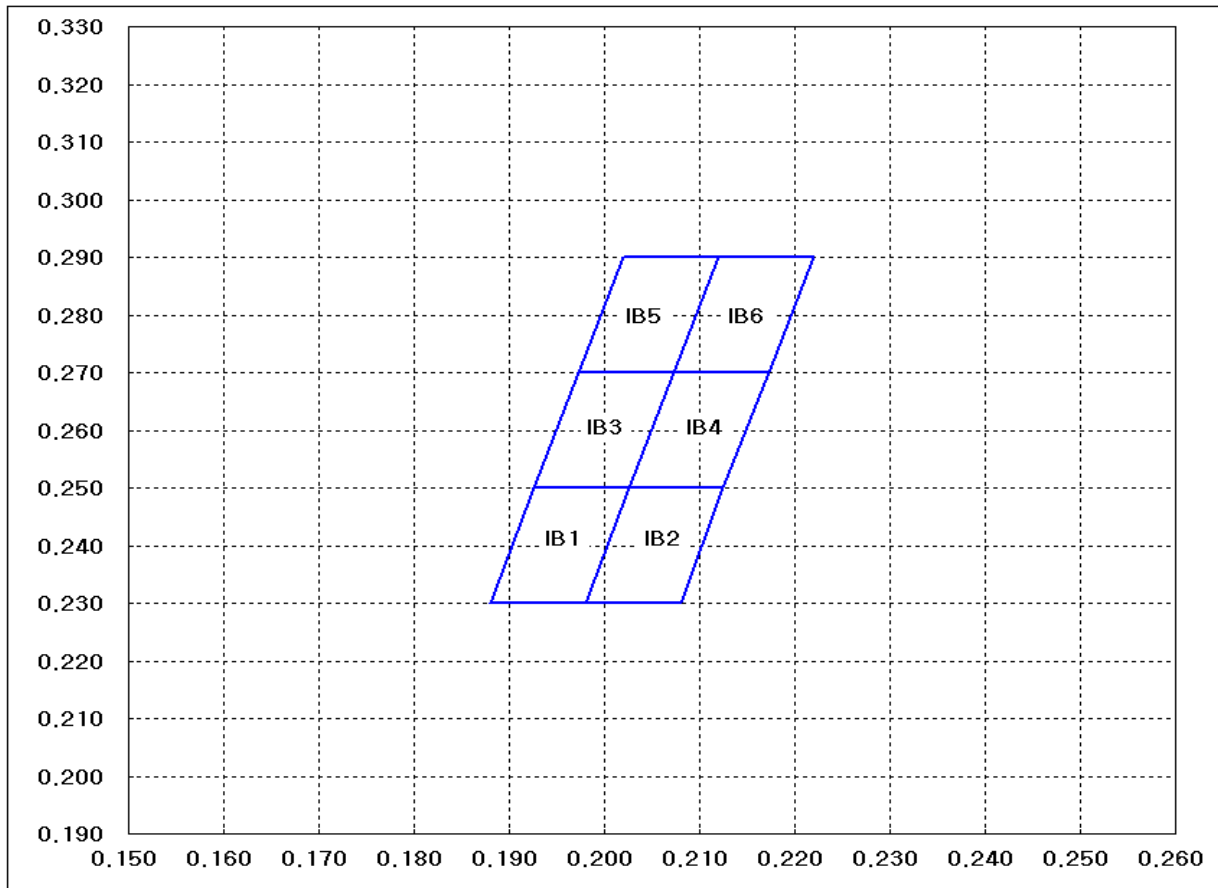

IB1		IB2		IB3		IB4		IB5		IB6	
x	y	x	y	x	y	x	y	x	y	x	y
0.1880	0.2300	0.1980	0.2300	0.1925	0.2500	0.2025	0.2500	0.1973	0.2700	0.2073	0.2700
0.1925	0.2500	0.2025	0.2500	0.1973	0.2700	0.2073	0.2700	0.2019	0.2900	0.2119	0.2900
0.2025	0.2500	0.2125	0.2500	0.2073	0.2700	0.2173	0.2700	0.2119	0.2900	0.2220	0.2900
0.1980	0.2300	0.2080	0.2300	0.2025	0.2500	0.2125	0.2500	0.2073	0.2700	0.2173	0.2700

⁴⁾ The allowance of color coordinates measurement is within ± 0.01 . (CIE1931 standard colorimetric system)

6. Materials

item	material
LED chip	InGaN
Wire	Gold
PCB	C3965 (Cu/Ni/Au plating)
encapsulation	Epoxy + Silicone resin

7. Taping

7.1. tape

(units : mm)

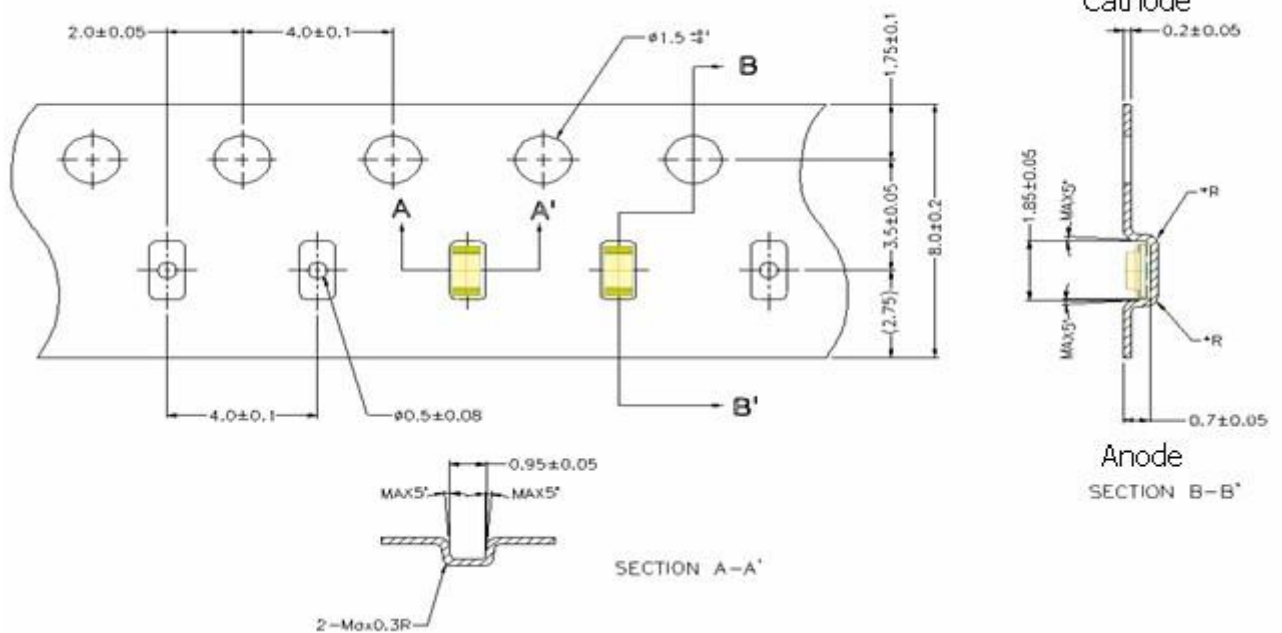

7.2. wheel (color : black)

(units : mm)

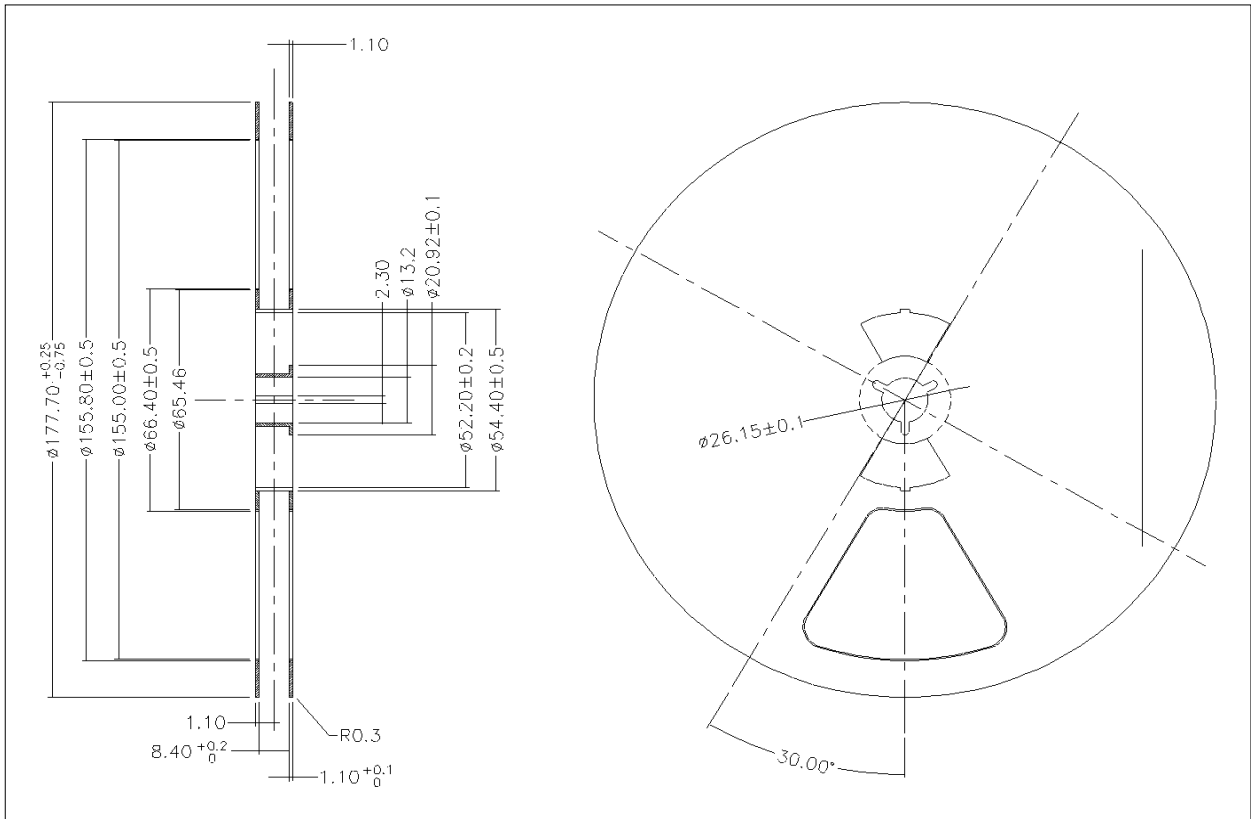

- quantity per reel LIB1000 : 5,000pcs

7.3. label

part no.

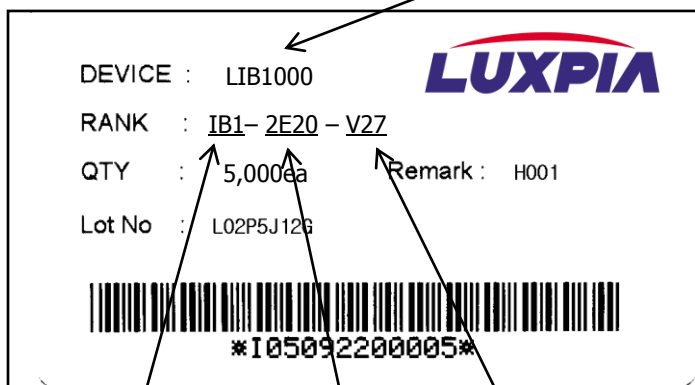

size (L X W) : 85mm x 50mm

color rank

I_V rank

V_F rank

8. Packing

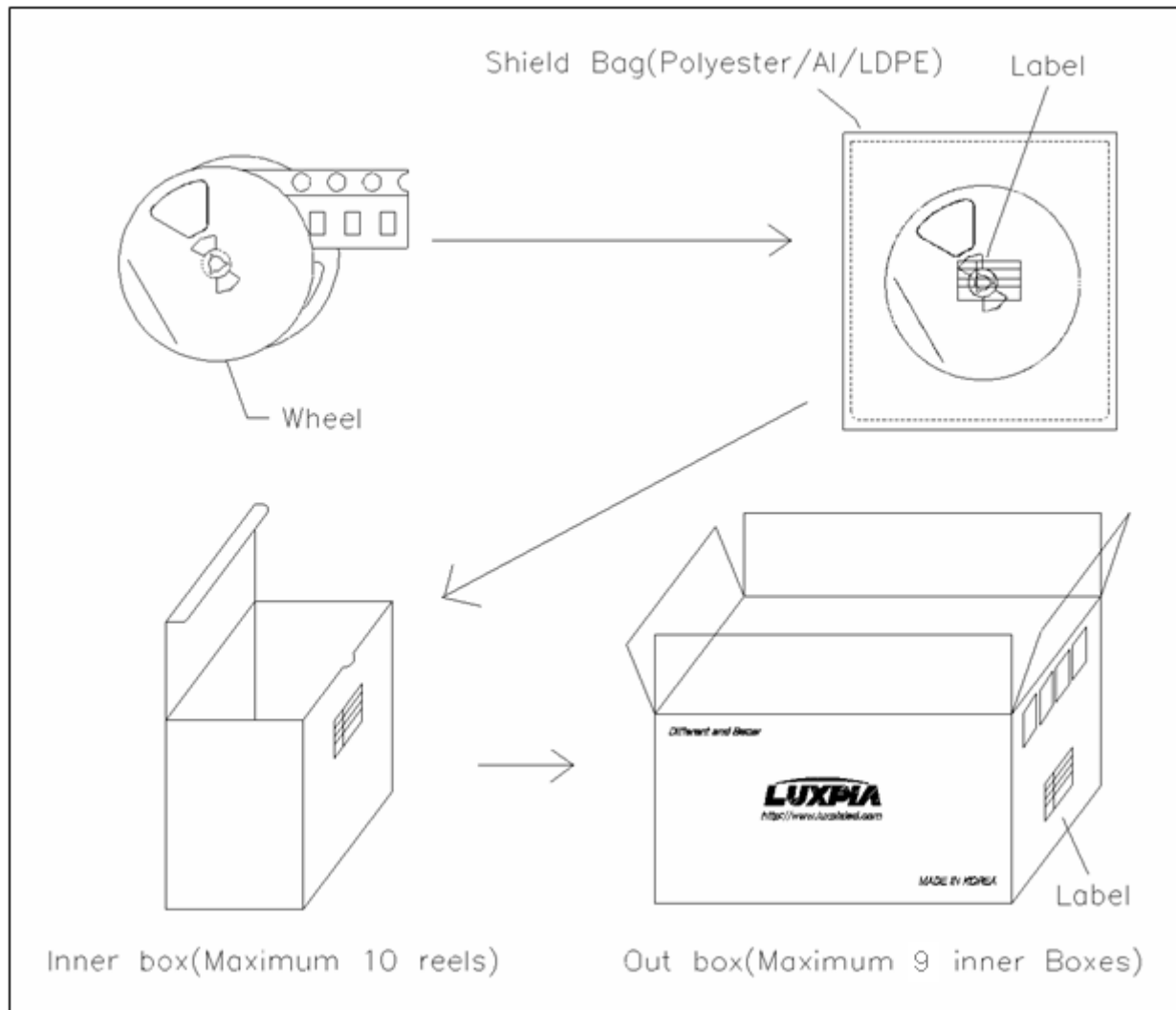

- The LEDs are packed in cardboard boxes after taping. The label shows part number, lot number, rank, and quantity.
- In order to protect the LEDs from mechanical shock, they are packed with cardboard boxes for transportation.
- The LEDs may be damaged if the boxes are dropped or receive a strong impact against them, so cautions must be taken to prevent any possible damage.
- The boxes are not water-resistant and, therefore, must be kept away from water and moisture.
- When the LEDs are transported, it is recommended that the same packing method as Luxpia's is used.
- If noticeable damage on a box appears upon arrival at the user's warehouse, the user should submit a claim to Luxpia within one week after arrival of the products.

9. Reliability

9.1. test items and results

no.	test item	Test Conditions	Note	number of damaged sample
1	resistance to soldering heat (reflow)	$T_{\text{slid}}=260^{\circ}\text{C}$, 10sec	2 times	0/22
2	solderability (reflow)	$T_{\text{slid}}=215\pm 5^{\circ}\text{C}$, 3sec	1 time over 95%	0/22
3	temperature cycle	-40°C through $+25^{\circ}\text{C}$ to $+85^{\circ}\text{C}$ (30min/5min/30min)	100 cycles	0/22
4	high temperature storage	$T_a=85^{\circ}\text{C}$	1000 hrs	0/22
5	high humidity and temperature storage	$T_a=60^{\circ}\text{C}$, RH=90%	1000 hrs	0/22
6	low temperature storage	$T_a=-30^{\circ}\text{C}$	1000 hrs	0/22
7	steady-state operating lifetime test	$T_a=25^{\circ}\text{C}$, $I_F=10\text{mA}$	500 hrs	0/22
8	steady-state operating lifetime of high humidity and temperature	$T_a=60^{\circ}\text{C}$, RH=90%, $I_F=5\text{mA}$	500 hrs	0/22
9	steady-state operating lifetime of low temperature	$T_a=-30^{\circ}\text{C}$, $I_F=10\text{mA}$	500 hrs	0/22

* Reliability is measure on the thermal emission PCB for LED Reliability test.

9.2. criteria for judging the damage

item	symbol	test condition	criteria for judgement	
			min	max
forward voltage	V_F	$I_F = 5\text{mA}$	-	U.S.L. ⁵⁾ $\times 1.2$
luminous intensity	I_V	$I_F = 5\text{mA}$	L.S.L. ⁶⁾ $\times 0.5$	-

⁵⁾ U.S.L. : upper standard level

⁶⁾ L.S.L. : lower standard level

10. Cautions

The LEDs are device which are materialized by combining Blue LEDs and special phosphors. Consequently, the color of White LEDs is subject to change a little by an operating current.

Care should be taken after due consideration when using LEDs.

(1) Moisture-Proof Package

- When moisture is absorbed into the SMT package it may vaporize and expand products during soldering. There is a possibility that this may cause exfoliation of the contacts and damage to the optical characteristics of the LEDs. For this reason, the moisture-proof package is used to keep moisture to a minimum in the package.
- A package of a moisture-absorbent material (silica gel) is inserted into the shielding bag. The silica gel changes its color from yellow to green as it absorbs moisture.

(2) Storage

• Storage Conditions

- After opening the package :

The LEDs should be kept at 5°C~40°C or less and 30%RH or less. The LEDs should be soldered within 24 hours after opening the package. If unused LEDs remain, they should be stored in moisture-proof packages, such as sealed containers with packages of moisture-absorbent material (silica gel). It is also recommended to return the LEDs to the original moisture-proof bag and to reseal the moisture-proof bag again.

• If the moisture-absorbent material (silica gel) has faded away or the LEDs have exceeded the recommended storage time, baking treatment should be performed using the following conditions.

- Baking treatment : more than 24 hours at 60±5°C (Reel condition)

more than 12 hours at 125±5°C (Each piece condition)

- Please avoid condition which may cause difficulty during soldering operations. It is recommended that the User use the LEDs as soon as possible.
- Please avoid rapid transitions in ambient temperature, especially in high humidity environments where condensation can occur.

(3) Heat Generation

• Thermal design of the end product is of paramount importance. Please consider the heat generation of the LED when the system is designed. The coefficient of temperature increase per input electric power is affected by the thermal resistance of the circuit board and density of LED placement on the board, as well as other components. It is necessary to avoid intense heat generation and operate within the maximum ratings given in the specification.

- The operating current should be decided after considering the ambient maximum temperature of LEDs.

(4) Soldering Conditions

- The LEDs can be soldered in place using the reflow soldering method. Luxpia does not make any guarantee on the LEDs after they have been assembled using the dip soldering method.
- Recommended soldering conditions

	Reflow Soldering		Hand Soldering	
	Lead Solder	Lead-free Solder	temperature	
pre-heat	120~150℃	200~220℃	soldering time	350℃ max 3sec max (one time only)
pre-heat time	120sec max	120sec max		
peak temperature	240℃ max	260℃ max		
soldering time	10sec max	5sec max		
condition	refer to profile ①	refer to profile ②		

* After reflow soldering, rapid cooling should be avoided.

[temperature-profile (surface of circuit board)]

Use the conditions shown to the following figures.

<① : Lead Solder>

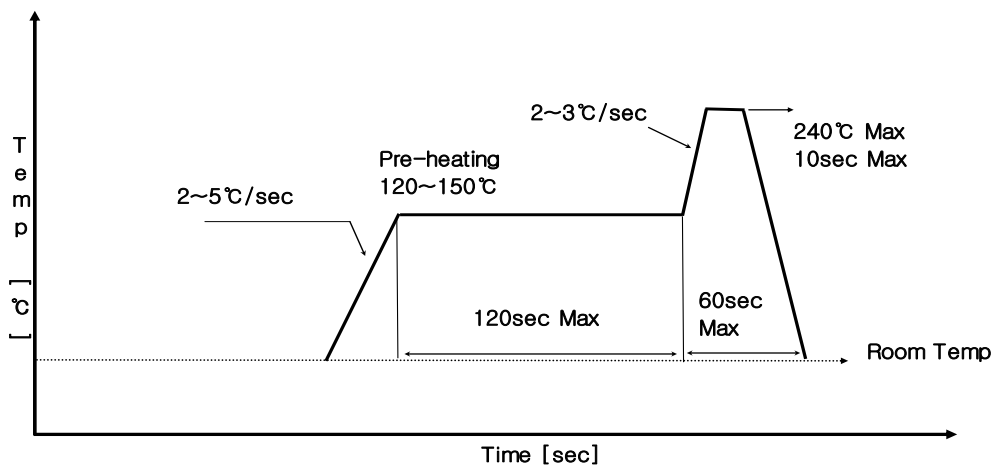

<② : Lead-free Solder>

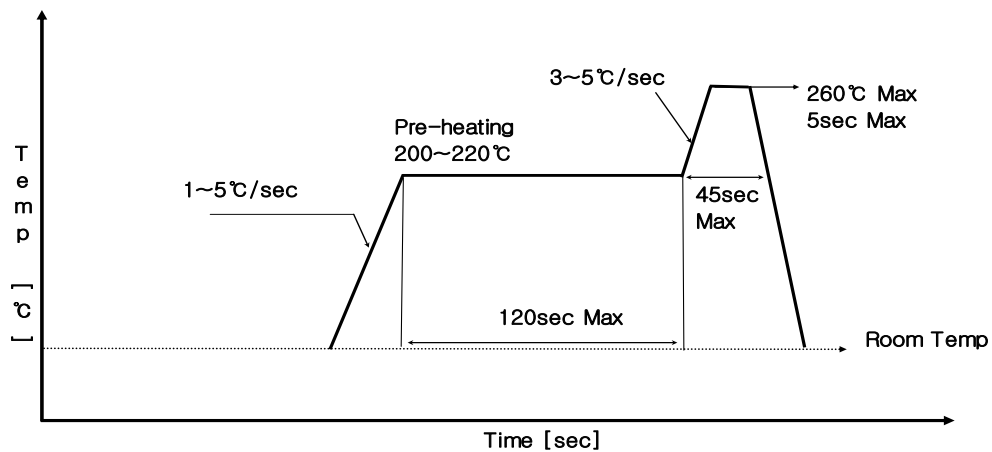

- Occasionally there is a brightness decrease caused by the influence of heat or ambient atmosphere during air reflow. It is recommended that the User use the nitrogen reflow method.
- Repairing should not be done after the LEDs have been soldered. When repairing is unavoidable, a double-head soldering iron should be used. It should be confirmed beforehand whether the characteristics of the LEDs will or will not be damaged by repairing.
- Reflow soldering should not be done more than two times.
- When soldering, do not put stress on the LEDs during heating.
- After soldering, do not warp the circuit board.

(7) Cleaning

- It is recommended that isopropyl alcohol be used as a solvent for cleaning the LEDs. When using other solvents, it should be confirmed beforehand whether the solvents will dissolve the package and the resin or not. Freon solvents should not be used to clean the LEDs because of worldwide regulations. Do not clean the LEDs by the ultrasonic. When it is absolutely necessary, the influence of ultrasonic cleaning on the LEDs depends on factors such as ultrasonic power and the assembled condition. Before cleaning, a pre-test should be done to confirm whether any damage to the LEDs will occur.

(8) Static Electricity

- Static electricity or surge voltage damages the LEDs. It is recommended that a wrist band or an anti-electrostatic glove be used when handling the LEDs.
 - All devices, equipment and machinery must be properly grounded. It is recommended that measurements be taken against surge voltage to the equipment that mounts the LEDs.
 - When inspecting the final products in which LEDs were assembled, it is recommended to check whether the assembled LEDs are damaged by static electricity or not. It is easy to find static-damaged LEDs by a light-on test or a V_F test at a lower current (below 1mA is recommended).
 - Damaged LEDs will show some unusual characteristics such as the leak current remarkably increases, the forward voltage becomes lower, or the LEDs do not light at the low current.
- criteria : $V_F > 1.8V$ at $I_F=0.5mA$

(9) Others

- This LED complies with RoHS Directive.
- The LED light output is strong enough to injure human eyes. Precautions must be taken to prevent looking directly at the LEDs with unaided eyes for more than a few seconds.
- Flashing lights have been known to cause discomfort in people; you can prevent this by taking precautions during use. Also, people should be cautious when using equipment that has had LEDs incorporated into it.
- The customer not reverse engineer by disassembling or analysis of the LEDs without having prior written consent from Luxpia. When defective LEDs are found, the User shall inform Luxpia directly before disassembling or analysis.
- The warranties of quality set forth herein are exclusive. All previous negotiations and agreements not specifically incorporated herein are superseded and rendered null and void.
- Both parties shall sincerely try to find a solution when any disagreement occurs regarding these specifications.
- These specifications can be revised upon mutual agreement.
- Luxpia understands that the User accepts the content of these specifications, if the User does not return these specifications with signatures within 3 weeks after receipt.
- The LEDs described in the specification are intended to be used for ordinary electronic equipment (such as office equipment, communications equipment, on the applications in which exceptional quality and reliability are required, particularly when the failure or malfunction of the LEDs may directly jeopardize life or health (such as for airplanes, aerospace, submersible repeaters, nuclear reactor control systems, automobiles, traffic control equipment, life support systems and safety devices)

11. Warranty

- (1) Luxpia warrants that its LEDs conform to the foregoing specifications and that Luxpia will convey good title to all LEDs sold.
- (2) LUXPIA disclaims all other warranties including the implied warranties of merchantability and fitness for a particular purpose.
- (3) In the event any LED supplied by Luxpia is found not to conform to the foregoing specifications within ninety days of receipt, Luxpia will repair or replace the LED, at Luxpia's discretion, provided that the User (a) promptly notifies Luxpia in writing of the details of the defect (b) ships the LEDs at the User's expense to Luxpia for examination, and (c) the defect is due to the negligence of Luxpia and not mishandling or misuse by the User.
- (4) Luxpia will not take responsibility for any trouble that is caused by using the LEDs at conditions exceeding our specifications.
- (5) These specifications are applied only when a LED stands alone and it is strongly recommended that the User of the LEDs confirms the properties upon assembly. Luxpia is not responsible for failures caused during and after assembling. It will be excepted from the rule if the failure would be caused undoubtedly by Luxpia.
- (6) A claim report stating details about the defect shall be made when returning defective LEDs. Luxpia will investigate the report immediately and inform the user of the results.
- (7) LUXPIA's liability for defective lamps shall be limited to replacement and in no event shall LUXPIA be liable for consequential damage or lost profits.
- (8) LUXPIA's guarantees that the chip paste and material stuck paste should not be blackened.

12. Characteristic Diagrams

* All characteristics shown are for reference only are not guarantee.

(1) forward voltage vs. forward current

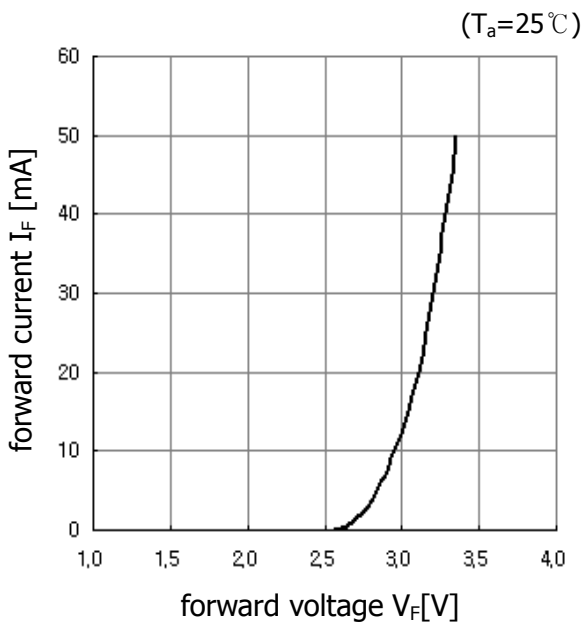

(2) forward current vs. relative luminosity

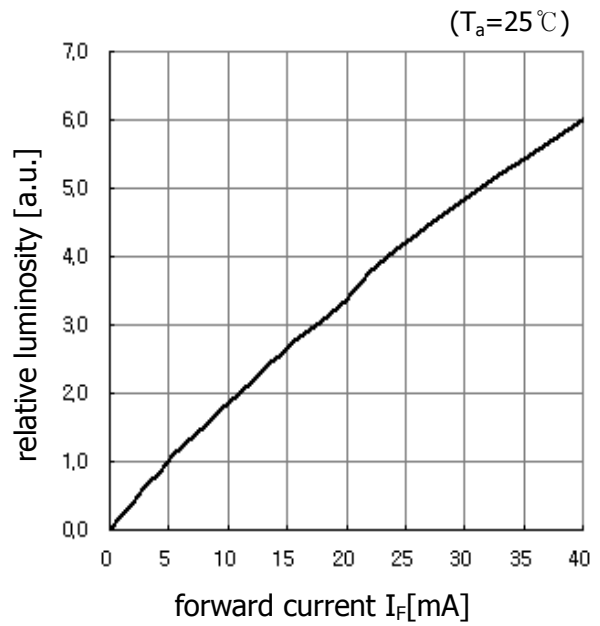

(3) ambient temperature vs. allowable forward current

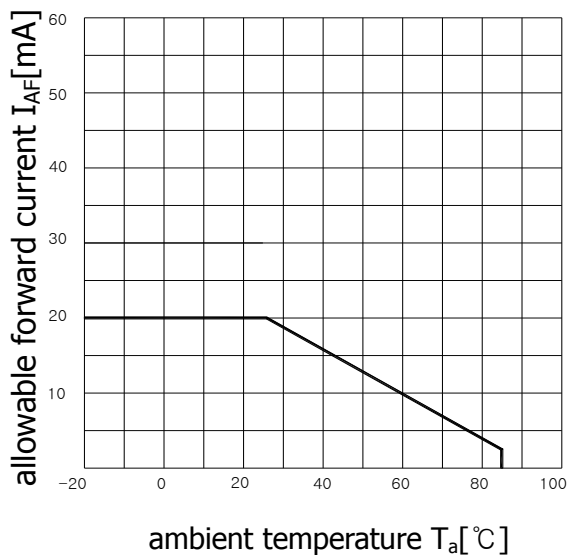

(4) ambient temperature vs. relative luminosity

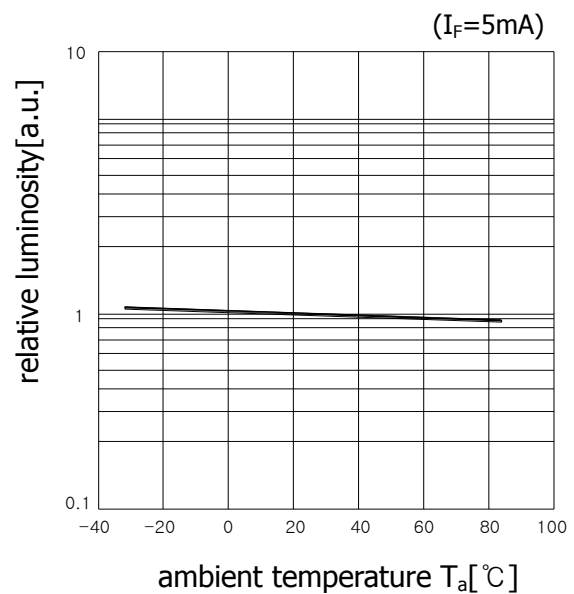

(7) relative spectral emission

$V(\lambda)$ = standard eye response curve

($T_a=25^\circ\text{C}$, $I_F=5\text{mA}$)

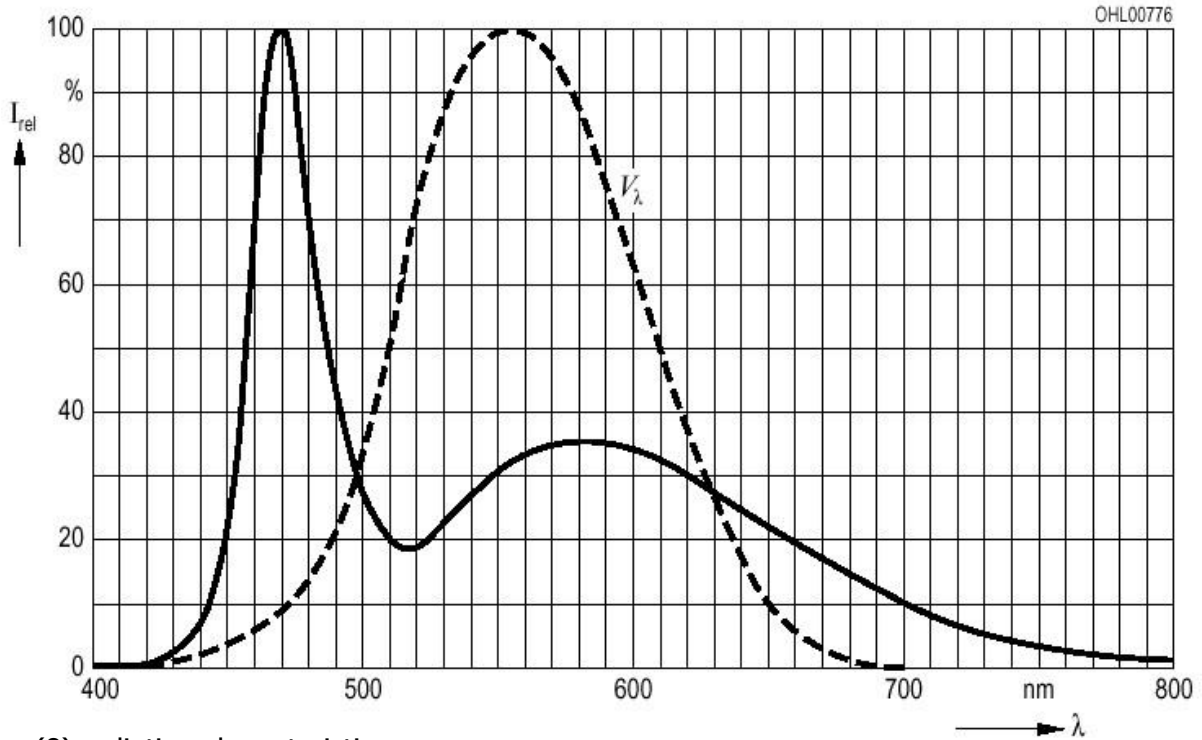

(8) radiation characteristics

($T_a=25^\circ\text{C}$, $I_F=5\text{mA}$)

